

SIGN	DESCRIPTION	DATE	APPROVER

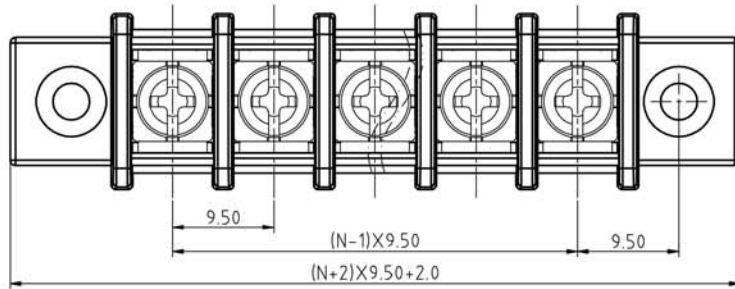

N=Number of contacts

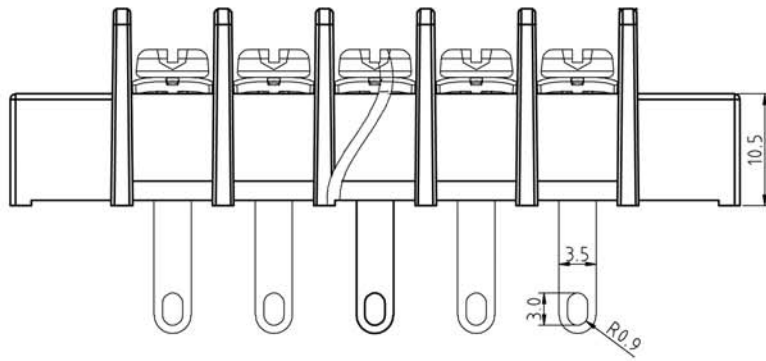

P.C.B LAYOUT

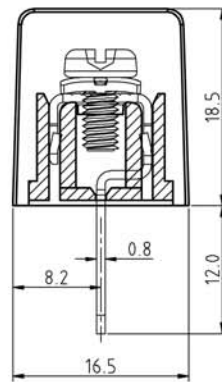
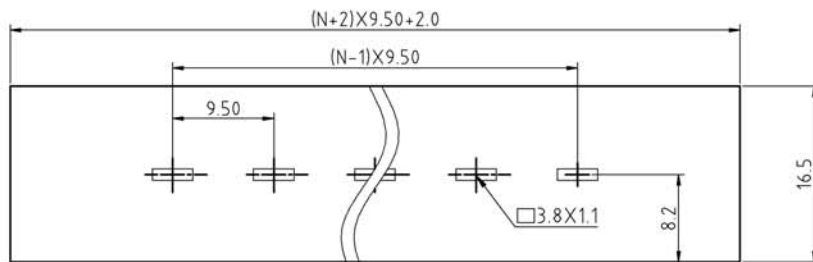

Technical Data:

Material:

Terminals: Copper Alloy, Tin Plated

Terminal screw: Steel galvanized with Cr³⁺ plated

Insulator body (housing): Polyamide (Glass filled) (UL94V-0)

Electrical

Voltage rating: 300VAC

Current rating: 25 Amps/way max

Contact resistance: 20mΩ (max)

Withstanding Voltage: 2500VAC(1min) Test time=60sec/1pcs

Wire range: 12-22AWG

Mechanical:

Torque: 10kgf.cm/M3.5

Operating temperature: -40°C to +105°C

Soldering reliability:

Test temperature= 250°C±10°C

5 seconds max

Ordering Information:

U111 - 4 - 9 XX - X X X 0

A Black Pa66

B Black Pbt

1 With flange

2 Without flange

1 "-" Screw Cr³⁺

2 "-/" Screw Cr³⁺

3 "-" Screw Ni Plated

4 "-/" Screw Ni Plated

02 2Pin

To To

32 32Pin

WELINK 上海拓尔普电子科技有限公司
Welink International Co., LTD.

TOLERANCE	APPROVED:	NAME:
X ±0.50	CHECKED:	U111-4 Pitch 9.5mm
X.X ±0.30	DRAWN: Yang Ming 2011,07,15	series With flange
X.XX ±0.20	UNITS: mm	PART NO: U11149XX21B0
X° ±1°	REV: A	DWG NO: 9U1114001A
SCALE: 2 / 1	PAGE: 1 / 1	